



THE FIRST STAINLESS STEEL SHATTAF

الشطاف الأول بالعالم الذي صنع من الحديد الغير قابل للصدأ

WASHROOM
SYSTEMS

FRANKE



FRANKE GROUP

بِسْمِ اللَّهِ الرَّحْمَنِ الرَّحِيمِ

الفولاذ المقاوم للصدأ

قدمت شركة فرانكي ١٠٠ عاما من الخبرة في تصنيع وتشكيل الصفائح الفولاذ المقاوم للصدأ. وقد أنشئت في سويسرا. وكانت الأولى بالعالم عام ١٩١١ واصبحت بذلك الرائدة بالاستثمارات في مجال الابتكار والتطور التكنولوجي مما جعلها الشركة الرائدة لتقدم مميزات غير محصورة في المواد والحلول حسب الطلب.

STAINLESS STEEL TRIED & TESTED

Franke offers a 100 years experience in manufacturing stainless steel. In 1911 the first sheet-metal fabrication has been established in Switzerland. Consequent investments in innovation and technological development enables Franke to offer exclusive material features and custom-made solutions.

الوكيل الوحيد بالمملكة العربية السعودية : مؤسسة سدر المعادن - جدة معرض سدر استينلس إستيل مدينة البناء - D-49 - هاتف : 6052992 - 02 جوال : 0535455588

www.sdr-metal.com.sa

E-mail: info@sdr-metal.com.sa

FRANKE GROUP

The Franke Artemis Group conducts its worldwide industrial business through Franke Kitchen Systems Group and Franke Commercial Systems Group.

In 2011 the Franke Artemis Group generated consolidated revenues of USD 3 billion. The Franke Artemis Group also manages an extensive real-estate portfolio (Franke Artemis Real Estate Group) in Switzerland and holds various strategic participations in listed Swiss companies (Franke Artemis Asset Management Group).

Franke Kitchen Systems Group

Franke Kitchen Systems

Franke Kitchen Systems is the world's leading provider of intelligent systems for domestic kitchens. Around the globe more customers place their trust in us than in any other manufacturer. Based on years of experience and specialist knowledge we establish rewarding and lasting partnerships.

Franke Commercial Systems Group

Franke Washroom Systems

Franke Washroom Systems is a world leading provider of intelligent washroom solutions to the public, semi-public and commercial sector. We continually raise our capability and performance in reliability, service, innovation and know how, enabling our professional customers to set benchmarks on their own.

Franke Foodservice Systems

Franke Foodservice Systems is the world's leading provider of comprehensive systems and services for the foodservice industry. We have almost 40 year's global experience in supporting the quick-service industry in optimising their methods.

Franke Coffee Systems

Franke Coffee Systems is a world leading provider of intelligent coffee systems. We serve our partners through innovation and customised solutions, enabling successful service concepts and the fine art of coffee-making.

Franke Beverage Systems

Franke Beverage Systems is the world's leading provider of intelligent beverage systems. We offer innovative, effective and environmentally friendly products and services which add and retain values for our partners.



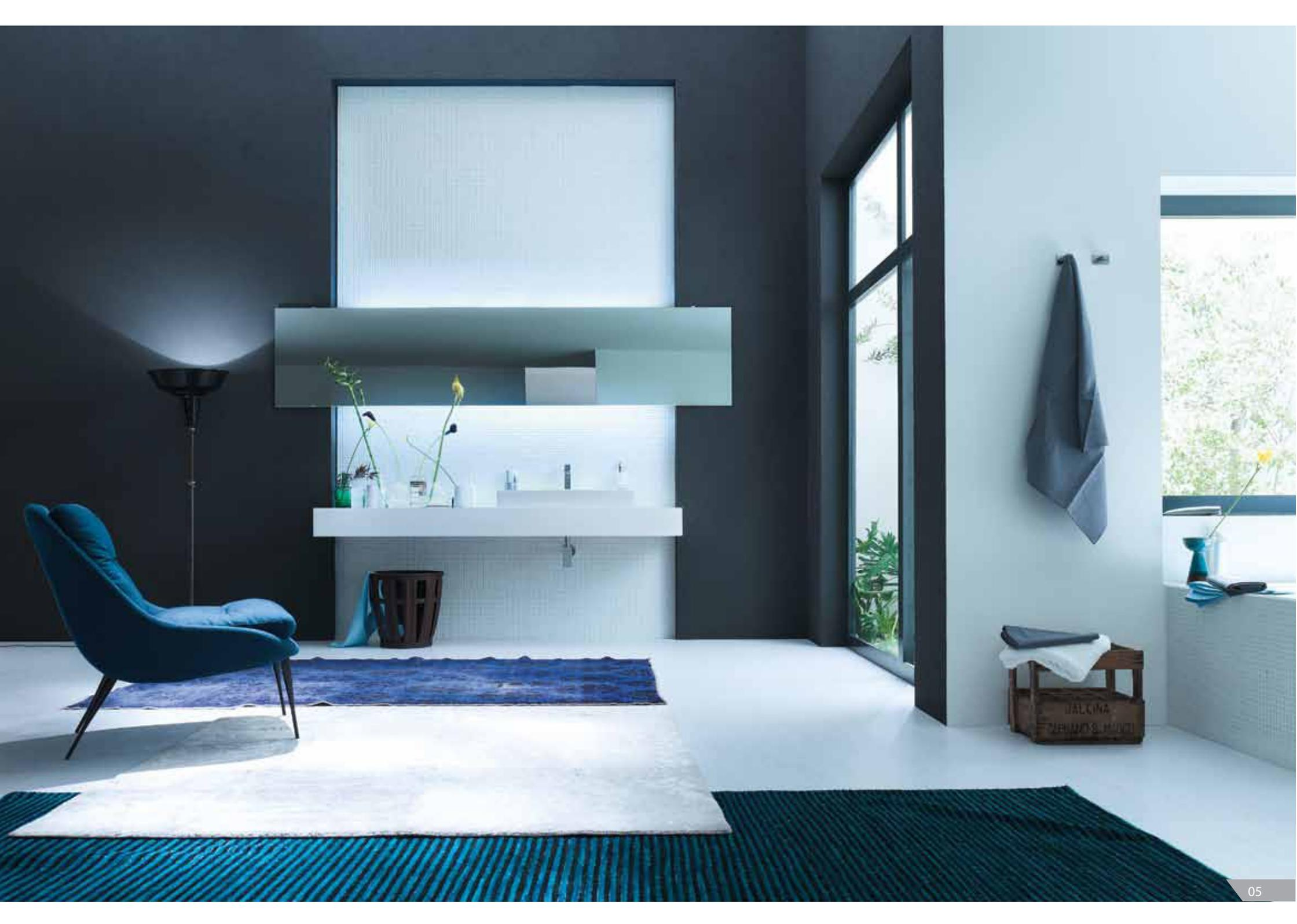

STAINLESS STEEL - ADVANTAGES IN AN OVERVIEW

RUST-FREE

Rust can only occur due to the action of outside influences

ACID-RESISTANT

Withstands the action of all commonly in households used acids

HYGIENIC

Easily disinfected against bacteria and viruses

EASY TO CARE

Cleaning is fast and simple - even with large amounts of accumulated dirt

NEUTRAL
COLOUR-TONE

Timeless in design - can be combined easily with other materials

VANDAL-RESISTANT

Highly durable against deliberate physical attack

HEAT
FLAME-RESISTANT

Cigarettes and other hot objects do not leave a mark on the surface

EASY TO REPAIR

Can be repaired on site if damage does occur

100%
RECYCLABLE

New stainless steel material is made of a minimum of 65 % former stainless steel products

الفولاذ المقاوم للصدأ - المزايا في لمحة عامة :

مقاومة للصدأ

يمكن أن يحدث الصدأ فقط نتيجة لحالات من التأثيرات الخارجية

مقاومة للأحماض

يقاوم عمل الأحماض المستخدمة بالمنزل

سهولة النظافة

سهولة التعقيم ضد البكتيريا والفيروسات

العناية

تنظيف سريع وبسيط - حتى مع كميات كبيرة من الأوساخ المتراكمة

اللون محايد

إختيارات غير محدودة في التصميم - يمكن الجمع بسهولة مع مواد أخرى

مقاومة التلف

دائم ضد الإتلاف والخراب ويعتمد عليه

مقاومة
المواد المشتعلة

النار بالسجائر والأجسام الساخنة الأخرى لا تترك أثرا على السطح

سهولة الإصلاح

يمكن اصلاحها في نفس الموقع

100% قابلة
لإعادة التدوير

تتكون مادة الفولاذ المقاوم للصدأ الجديدة لا تقل عن 65% من المنتجات القديمة من الفولاذ المقاوم للصدأ

THE FIRST STAINLESS STEEL SHATTAF

الشطاف الأول بالعالم الذي صنع من الحديد الغير قابل للصدأ





FRANKE ECOPLASTIC
Cartridge FRANKE Widd made
in non-toxic plastic.



FRANKE Stainless Steel
Stainless Steel with a minimum
percentage of lead.



FRANKE LIVEDRIVE
Clutch system for the SS Spring Grade 301
at low-friction. Smooth and fluid
movements of the handle are assured.



NEOPERL® CASCADE®
Two aerators are provided in the box
(versions: open and 5 l/min).



-50%
FRANKE WATERSAVING
Dynamic flow regulator. The lever
elevation is easily controlled halfway so the
water consumption decreases by 50%.



Body Stainless Steel
Franke Bright Body Made From
SS Grade 304 (18110)
Bright and Shiny



PARIGI® PARINOX® SOFTPEX®
Highly resistant hoses with superior
inner hygienic properties.



Spring- Unique combination of hardness and toughness.
corrosion resistance Made from Austenitic Stainless Steel Grade 301
Std. ASTM A313/ A313 M

Body: the first Shattaf Head in the world -
Unique Design made from Stainless Steel Grade 304(18/10), Elegant , Light weight with Full Warranty 2 Years.



Handle
Unique Handle/ Screw made from Stainless Steel Grade 304(18/10)
SOFT HANDLING, ever made
With adjustable Steady water flow

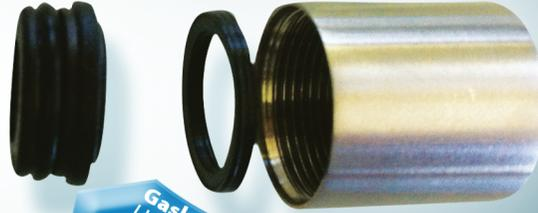

Gasket
Unique, O- ring gasket : made from, ETHYLENE-PROPYLENE (EPDM)-With Excellent resistance to all kind of water, Hardness-Shore A= 70
ASTM D1418 Designation



Shattaf

- Shattaf head is made of stainless steel material
- Complete with Shattaf holder (BD001-N) and 1.2meters chrome plated hose with inner PVC lining
- 128x25x62 mm

SHTX001N

2000106367

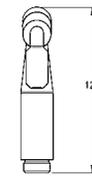
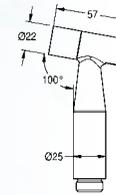

يتميز بالسوستة تتحرك أفقياً لدفع الماء
تجعل حركة المقبض كالحرير والفريد
لدفع الماء كالرغوة الناعمة ويتميز
بسهولة التحكم بكمية الماء

4 مميزات فريدة ليس لها نظير
4 Unique Advantages



Shattaf

- Shattaf Head is made of ABS plastic material
- Complete with Shattaf holder (DF439) and 1.2 meters Braided hose made of PVC white material
- 115x37x76 mm

SHTX439

2000106369

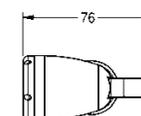
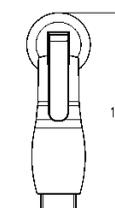
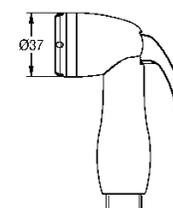

FRANKE HOTEL AND RESIDENTIAL ACCESSORIES IN STAINLESS STEEL

Although they contribute to only a fraction of a bathroom, no bathroom is complete without accessories. Franke's assortment of 304 Stainless Steel Accessories puts the finishing touches to a perfectly matching range of designs. Each range is created with different styles in mind, making it easy for a designer to integrate these accessories with almost any kind of design concept.

Stainless Steel

High-quality Material

Stainless steel is considered to be the best material in terms of hygiene and durability all over the world. It is not only resistant to moisture and most acids, it also stands out due to its hardness, durability, high tolerance of heat and cold, and hygienic characteristics. Dirt and oil can easily be washed from the smooth, pore-free surface. Scratches and grooves on covers lose their sharp edges quickly and blend in to the surface.

Stainless steel contains at least 10.5% chromium (Cr) and no more than 1.2% carbon (C). They form a self-regenerating surface layer (passive layer) that gives the material its resistance to corrosion, thereby ensuring significantly improved characteristics compared to unalloyed steels. Franke uses steels with higher chromium content and nickel as an additional alloy component for its sanitary fixtures. This combination further increases resistance to corrosion.

Source: Yasar Renkci, dipl. Engineer Metallurgy TU, Franke

Characteristics of 304 Stainless Steel

- High level of corrosion-resistance
- Non-magnetic
- Acid resistant, hygienic and easy to clean

All accessories are available in Satin Finished and High Polished.



Stainless steel High Polished



Stainless steel Satin Finished



Page 38-43

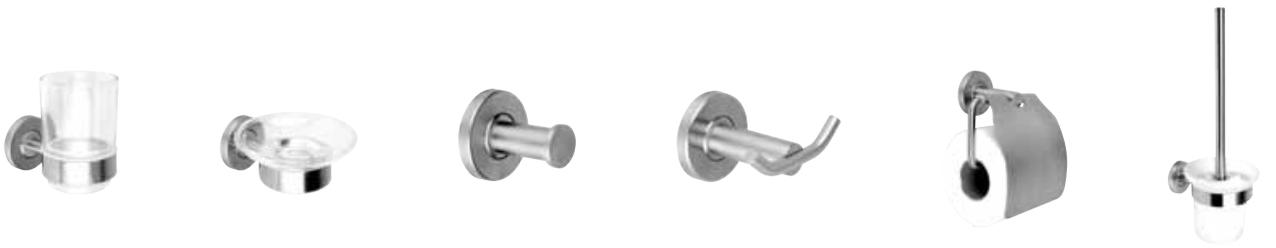

Page 44-50



Single Towel Rail



Medius

- Single Towel Rail for wall mounting
- 304 Stainless steel
- Round covers to conceal the fixing of screws
- Including SS screws and dowels
- 600x85x54 mm

MEDX001 2000106242
Satin Finished

MEDX001HP 2000106243
High Polished

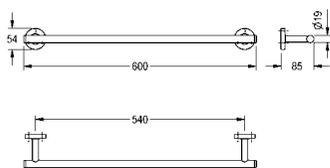

Firmus

- Single Towel Rail for wall mounting
- 304 Stainless steel
- Round covers with drilled hole on bottom for fixation
- Including SS screws and dowels
- 600x80x60 mm

FIRX001 2000106264
Satin Finished

FIRX001HP 2000106265
High Polished

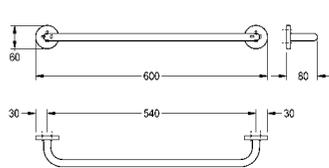

Icarus

- Single Towel Rail for wall mounting
- 304 Stainless steel
- Round covers with drilled hole on bottom for fixation
- Including SS screws and dowels
- 600x80x60 mm

ICAX001 2000106294
Satin Finished

ICAX001HP 2000106295
High Polished

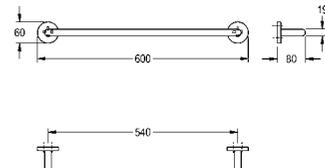

Venus

- Single Towel Rail for wall mounting
- 304 Stainless steel
- Drilled hole on bottom for fixation
- Including SS screws and dowels
- 610x78x30 mm

VENX001 2000106322
Satin Finished

VENX001HP 2000106323
High Polished

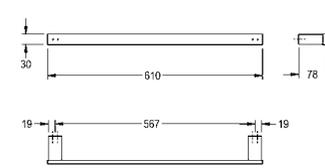

Cubus

- Single Towel Rail for wall mounting
- 304 Stainless steel
- Square covers with drilled hole on bottom for fixation
- Including SS screws and dowels
- 600x80x54 mm

CUBX001 2000106344
Satin Finished

CUBX001HP 2000106345
High Polished

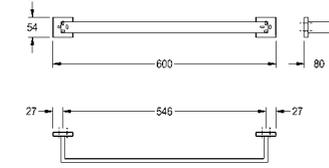

Double Towel Rail



Medius

- Double Towel Rail for wall mounting
- 304 Stainless steel
- Round covers to conceal the fixing of screws
- Including SS screws and dowels
- 600x125x54 mm

MEDX002 2000106244
Satin Finished

MEDX002HP 2000106245
High Polished

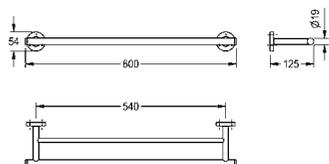

Firmus

- Double Towel Rail for wall mounting
- 304 Stainless steel
- Round covers with drilled hole on bottom for fixation
- Including SS screws and dowels
- 600x200x60 mm

FIRX002 2000106266
Satin Finished

FIRX002HP 2000106267
High Polished

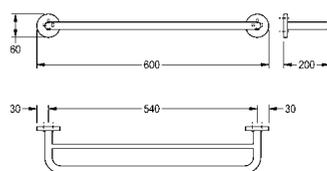

Icarus

- Double Towel Rail for wall mounting
- 304 Stainless steel
- Round covers with drilled hole on bottom for fixation
- Including SS screws and dowels
- 600x125x60 mm

ICAX002 2000106296
Satin Finished

ICAX002HP 2000106297
High Polished

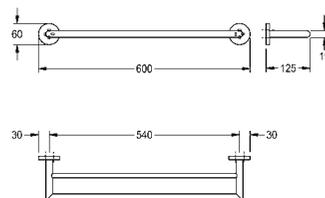

Venus

- Double Towel Rail for wall mounting
- 304 Stainless steel
- Drilled hole on bottom for fixation
- Including SS screws and dowels
- 610x120x30 mm

VENX002 2000106324
Satin Finished

VENX002HP 2000106325
High Polished

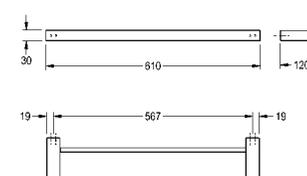

Cubus

- Double Towel Rail for wall mounting
- 304 Stainless steel
- Square covers with drilled hole on bottom for fixation
- Including SS screws and dowels
- 600x125x54 mm

CUBX002 2000106346
Satin Finished

CUBX002HP 2000106347
High Polished

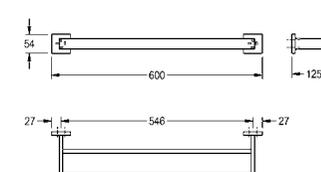

Double Towel Rack



Medius

- Double Towel Rack in combination of towel shelf and rail for wall mounting
- 304 Stainless steel
- Round cover to conceal the fixing of screws
- Including SS screws and dowels
- 600x220x120 mm

MEDX012 2000106256
Satin Finished

MEDX012HP 2000106257
High Polished

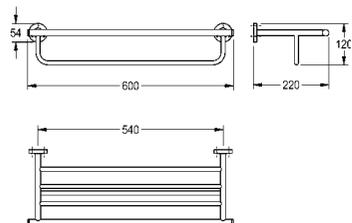

Firmus

- Double Towel Rack in combination of towel shelf and rail for wall mounting
- 304 Stainless steel
- Round covers with drilled hole on bottom for fixation
- Including SS screws and dowels
- 600x220x115 mm

FIRX012 2000106280
Satin Finished

FIRX012HP 2000106281
High Polished

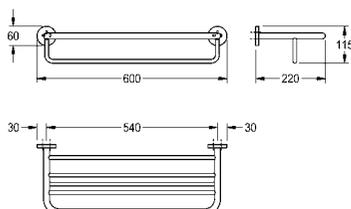

Icarus

- Double Towel Rack in combination of towel shelf and rail for wall mounting
- 304 Stainless steel
- Including SS screws and dowels
- 600x230x150 mm

ICAX112 2000106316
Satin Finished

ICAX112HP 2000106317
High Polished

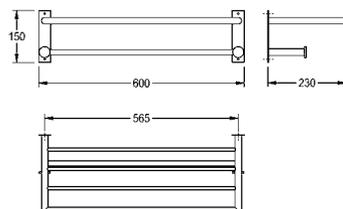

Venus

- Triple Towel Rack for wall mounting
- 304 Stainless steel
- Drilled hole on bottom for fixation
- Including SS screws and dowels
- 610x210x30 mm

VENX312 2000106342
Satin Finished

VENX312HP 2000106343
High Polished

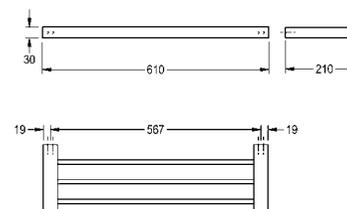

Cubus

- Double Towel Rack in combination of towel shelf and rail for wall mounting
- 304 Stainless steel
- Square cover with drilled hole on bottom for fixation
- Including SS screws and dowels
- 600x220x122 mm

CUBX012 2000106360
Satin Finished

CUBX012HP 2000106361
High Polished

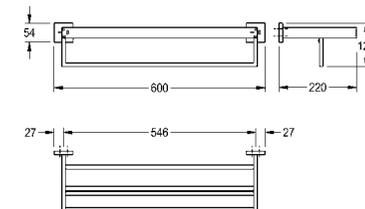



Medius

- Glass shelf with rail for wall mounting
- 304 Stainless steel
- Round cover to conceal the fixing of screws
- Including SS screws and dowels
- 500x140x60 mm

MEDX103 2000106258
Satin Finished

MEDX103HP 2000106259
High Polished

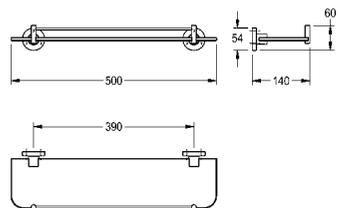

Firmus

- Glass shelf for wall mounting
- 304 Stainless steel frame
- Round cover to conceal the fixing of screws
- Including SS screws and dowels
- 600x155x60 mm

FIRX203 2000106290
Satin Finished

FIRX203HP 2000106291
High Polished

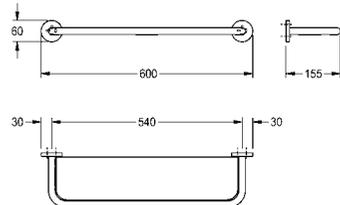

Icarus

- Glass shelf with rail for wall mounting
- 304 Stainless steel
- Stainless steel wall fixing holders
- Including SS screws and dowels
- 500x128x45 mm

ICAX103 2000106310
Satin Finished

ICAX103HP 2000106311
High Polished

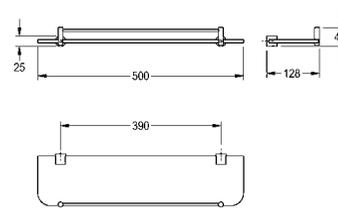

Venus

- Glass shelf for wall mounting
- 304 Stainless steel frame
- Drilled hole on bottom for fixation
- Including SS screws and dowels
- 510x120x30 mm

VENX003 2000106326
Satin Finished

VENX003HP 2000106327
High Polished

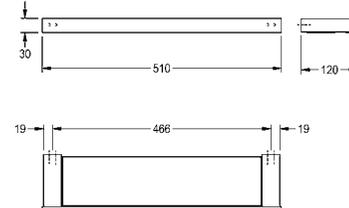

Cubus

- Glass shelf for wall mounting
- 304 Stainless steel frame
- Square covers with drilled hole on bottom for fixation
- Including SS screws and dowels
- 564x140x54 mm

CUBX003 2000106348
Satin Finished

CUBX003HP 2000106349
High Polished

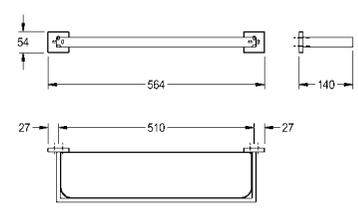

Towel Arm



Medius

- Towel arm for wall mounting
- 304 Stainless steel
- Round covers to conceal the fixing of screws
- Including SS screws and dowels
- 238x70x54 mm

Firmus

- Towel arm for wall mounting
- 304 Stainless steel
- Round covers with drilled hole on bottom for fixation
- Including SS screws and dowels
- 260x65x60 mm

Icarus

- Towel arm for wall mounting
- 304 Stainless steel
- Round covers with drilled hole on bottom for fixation
- Including SS screws and dowels
- 240x70x60 mm

Venus

- Towel arm for wall mounting
- 304 Stainless steel
- Drilled hole on bottom for fixation
- Including SS screws and dowels
- 270x70x30 mm

Cubus

- Towel arm for wall mounting
- 304 Stainless steel
- Square covers with drilled hole on bottom for fixation
- Including SS screws and dowels
- 262x85x54 mm

MEDX004 2000106246
Satin Finished

FIRX004 2000106270
Satin Finished

ICAX004 2000106298
Satin Finished

VENX004 2000106328
Satin Finished

CUBX004 2000106350
Satin Finished

MEDX004HP 2000106247
High Polished

FIRX004HP 2000106271
High Polished

ICAX004HP 2000106299
High Polished

VENX004HP 2000106329
High Polished

CUBX004HP 2000106351
High Polished

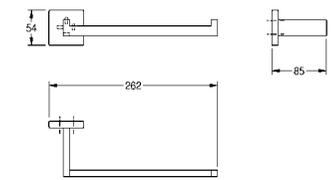
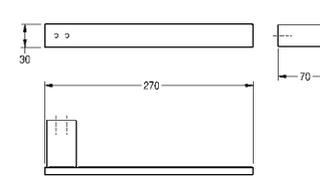
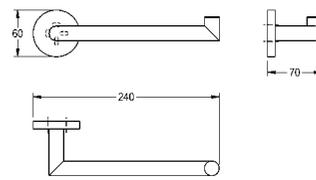
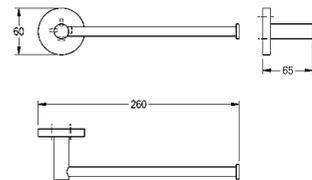
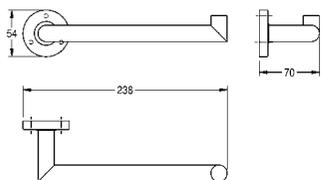



Medius

- Towel Ring for wall mounting
- 304 Stainless steel
- Round covers to conceal the fixing of screws
- Including SS screws and dowels
- 177x65x198 mm

MEDX104 2000106384
Satin Finished

MEDX104HP 2000106385
High Polished

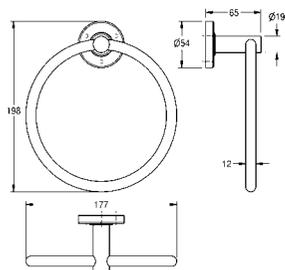

Firmus

- Towel Ring for wall mounting
- 304 Stainless steel
- Round covers with drilled hole on bottom for fixation
- Including SS screws and dowels
- Satin finished
- 187x65x210 mm

FIRX104 2000106282
Satin Finished

FIRX104HP 2000106283
High Polished

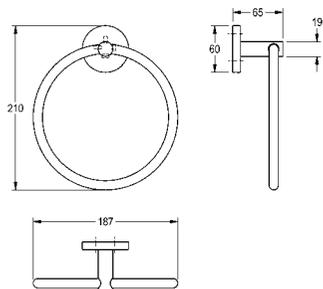

Icarus

- Rectangular Towel Ring for wall mounting
- 304 Stainless steel
- Round covers with drilled hole on bottom for fixation
- Including SS screws and dowels
- 210x70x127 mm

ICAX104 2000106312
Satin Finished

ICAX104HP 2000106313
High Polished

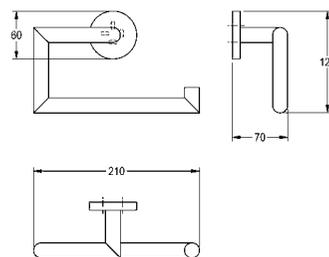

Tumbler Holder



Medius

- Tumbler holder for wall mounting
- 304 Stainless steel
- Glass Cup
- Round covers to conceal the fixing of screws
- Including SS screws and dowels
- 70x105x100 mm

MEDX006 2000106250
Satin Finished

MEDX006HP 2000106251
High Polished

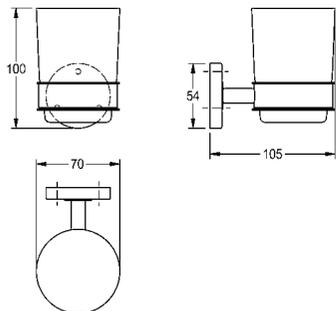

Firmus and Icarus

- Tumbler holder for wall mounting
- 304 Stainless steel
- Glass Cup
- Round covers with drilled hole on bottom for fixation
- Including SS screws and dowels
- 70x105x103 mm

FIRX006 2000106274
Satin Finished

FIRX006HP 2000106275
High Polished

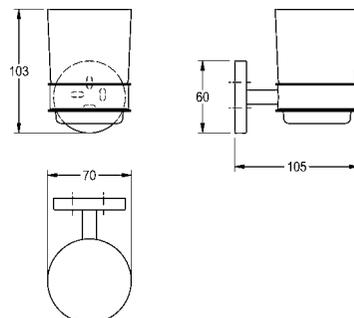

Venus

- Tumbler holder for wall mounting
- 304 Stainless steel
- Square Glass Cup
- Drilled holes on bottom for fixation
- Including SS screws and dowels
- 68x98x85 mm

VENX006 2000106332
Satin Finished

VENX006HP 2000106333
High Polished

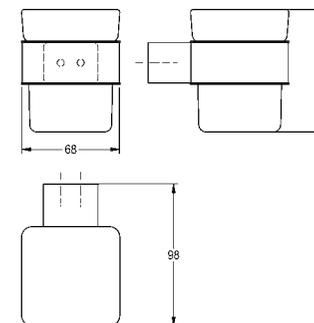

Cubus

- Tumbler holder for wall mounting
- 304 Stainless steel
- Square Glass Cup
- Square cup with drilled holes on bottom for fixation
- Including SS screws and dowels
- 127x115x85 mm

CUBX006 2000106354
Satin Finished

CUBX006HP 2000106355
High Polished

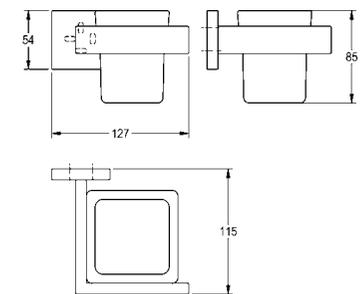



Medius

- Soap Dish for wall mounting
- 304 Stainless steel
- Glass Dish
- Round covers to conceal the fixing of screws
- Including SS screws and dowels
- 110x125x55 mm

MEDX007 2000106252
Satin Finished

MEDX007HP 2000106253
High Polished

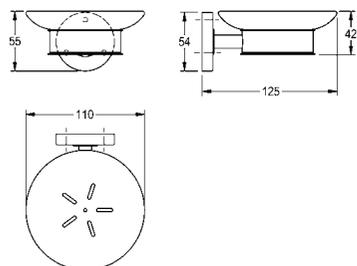

Firmus

- Stainless steel Soap Dish for wall mounting
- 304 Stainless steel
- Round covers with drilled hole on bottom for fixation
- Including SS screws and dowels
- 155x125x60 mm

FIRX107 2000106284
Satin Finished

FIRX107HP 2000106285
High Polished

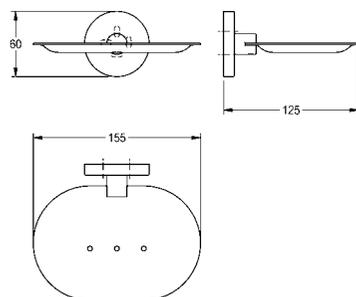

Icarus

- Soap Dish for wall mounting
- 304 Stainless steel
- Glass Dish
- Round covers with drilled hole on bottom for fixation
- Including SS screws and dowels
- 110x125x60 mm

ICAX007 2000106304
Satin Finished

ICAX007HP 2000106305
High Polished

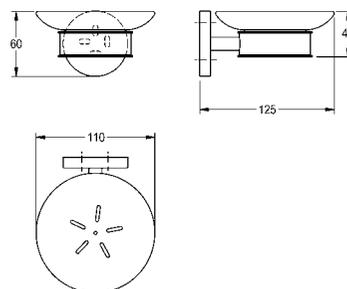

Venus

- Soap Dish for wall mounting
- 304 Stainless steel
- Square Glass Dish
- Drilled holes on bottom for fixation
- Including SS screws and dowels
- 98x113x47 mm

VENX007 2000106334
Satin Finished

VENX007HP 2000106335
High Polished

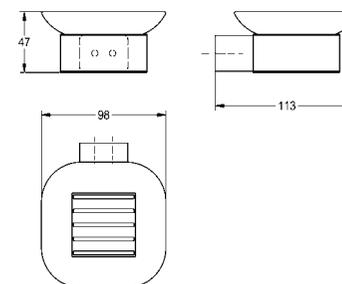

Cubus

- Soap Dish for wall mounting
- 304 Stainless steel
- Glass Dish
- Square covers with drilled hole on bottom for fixation
- Including SS screws and dowels
- 147x135x54 mm

CUBX007 2000106356
Satin Finished

CUBX007HP 2000106357
High Polished

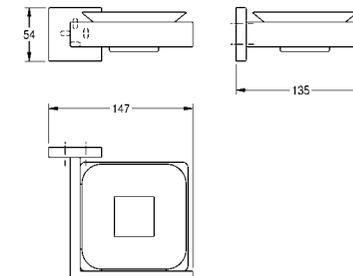

Robe Hook



Medius

- Single robe hook for wall mounting
- 304 Stainless steel
- Round cover to conceal the fixing of screws
- Including SS screws and dowels
- 54x55x54 mm

Firmus and Icarus

- Single robe hook for wall mounting
- 304 Stainless steel
- Round covers with drilled hole on bottom for fixation
- Including SS screws and dowels
- 60x54x60 mm

Venus

- Single robe hook for wall mounting
- 304 Stainless steel
- Drilled hole on bottom for fixation
- Including SS screws and dowels
- 30x50x65 mm

Cubus

- Single Towel Rail for wall mounting
- 304 Stainless steel
- Square covers with drilled hole on bottom for fixation
- Including SS screws and dowels
- 54x60x54 mm

MEDX010 2000106254
Satin Finished

FIRX010 2000106278
Satin Finished

VENX010 2000106336
Satin Finished

CUBX010 2000106358
Satin Finished

MEDX010HP 2000106255
High Polished

FIRX010HP 2000106279
High Polished

VENX010HP 2000106337
High Polished

CUBX010HP 2000106359
High Polished

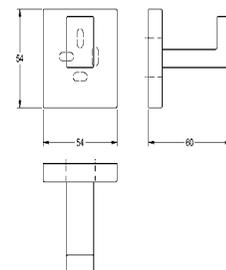
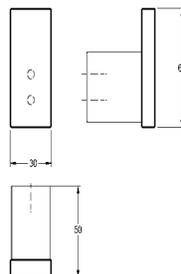
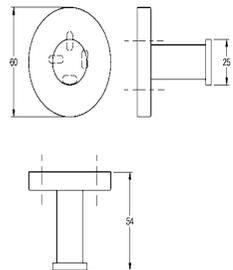
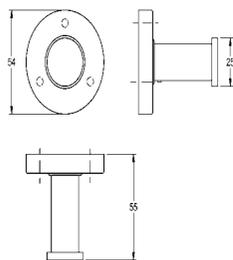

Medius

- Double robe hook for wall mounting
- 304 Stainless steel
- Round cover to conceal the fixing of screws
- Including SS screws and dowels
- 75x70x54 mm

Firmus and Icarus

- Double robe hook for wall mounting
- 304 Stainless steel
- Round covers with drilled hole on bottom for fixation
- Including SS screws and dowels
- 75x69x60 mm

MEDX0110 2000106260
Satin Finished

FIRX0110 2000106286
Satin Finished

MEDX0110HP 2000106261
High Polished

FIRX0110HP 2000106287
High Polished

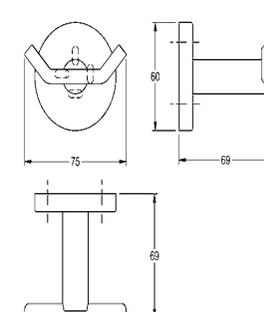
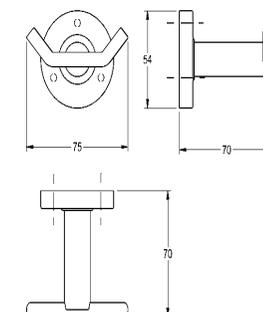

Toilet Roll Holder

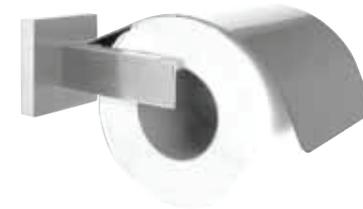

Medius

- Toilet Roll Holder for wall mounting
- 304 Stainless steel
- For 1 roll max with max. Ø 130 mm
- Stainless steel folding cover
- Round cover to conceal the fixing of screws
- Including SS screws and dowels
- 140x65x160 mm

MEDX111 2000106262
Satin Finished

MEDX111HP 2000106263
High Polished

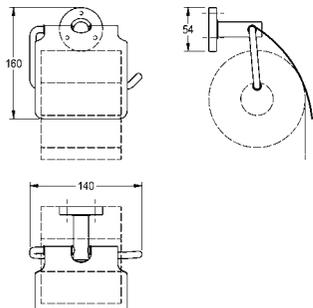

Firmus

- Toilet Roll Holder for wall mounting
- 304 Stainless steel
- For 1 roll max with max. Ø 130 mm
- Stainless steel folding cover
- Round covers with drilled hole on bottom for fixation
- Including SS screws and dowels
- 140x65x162 mm

FIRX111 2000106288
Satin Finished

FIRX111HP 2000106289
High Polished

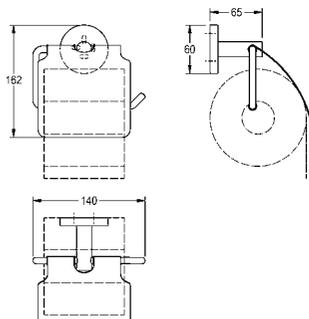

Icarus

- Toilet Roll Holder for wall mounting
- 304 Stainless steel
- For 1 roll max with max. Ø 130 mm
- Stainless steel folding cover
- Round covers with drilled hole on bottom for fixation
- Including SS screws and dowels
- 140x65x177 mm

ICAX111 2000106314
Satin Finished

ICAX111HP 2000106315
High Polished

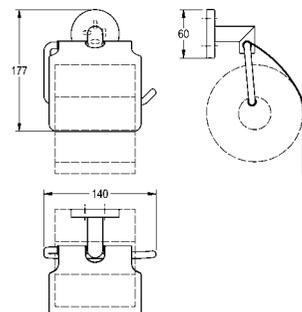

Venus and Cubus

- Toilet Roll Holder for wall mounting
- 304 Stainless steel
- For 1 roll max with max. Ø 130 mm
- Stainless steel folding cover
- Square cover with drilled hole on bottom for fixation
- Including SS screws and dowels
- 165x179x54 mm

CUBX111 2000106362
Satin Finished

CUBX111HP 2000106363
High Polished

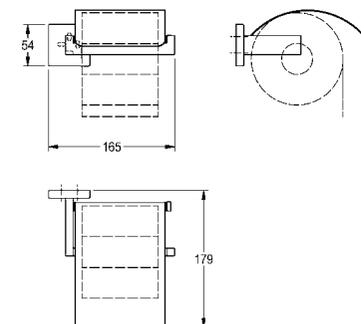



Firmus

- Spare Toilet Roll Holder (horizontal) for wall mounting
- 304 Stainless steel
- Round covers with drilled hole on bottom for fixation
- Including SS screws and dowels
- 170x65x60 mm

FIRX211 2000106292
Satin Finished

FIRX211HP 2000106293
High Polished

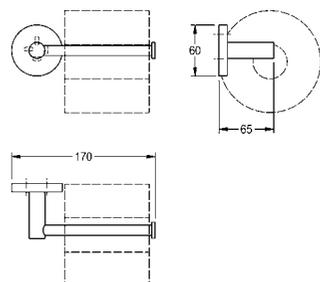

Icarus

- Spare Toilet Roll Holder (horizontal) for wall mounting
- 304 Stainless steel
- Round covers with drilled hole on bottom for fixation
- Including SS screws and dowels
- 180x70x60 mm

ICAX211 2000106318
Satin Finished

ICAX211HP 2000106319
High Polished

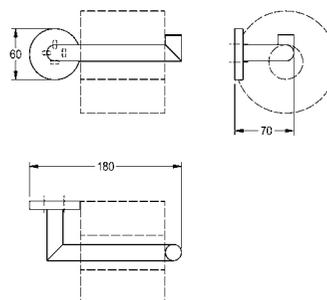

Venus

- Spare Toilet Roll Holder (horizontal) for wall mounting
- 304 Stainless steel
- Drilled hole on bottom for fixation
- Including SS screws and dowels
- 175x70x37 mm

VENX211 2000106340
Satin Finished

VENX211HP 2000106341
High Polished

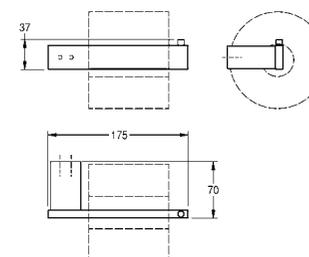

Cubus

- Spare Toilet Roll Holder (horizontal) for wall mounting
- 304 Stainless steel
- Square covers with drilled hole on bottom for fixation
- Including SS screws and dowels
- 165x85x54 mm

CUBX211 2000106364
Satin Finished

CUBX211HP 2000106365
High Polished

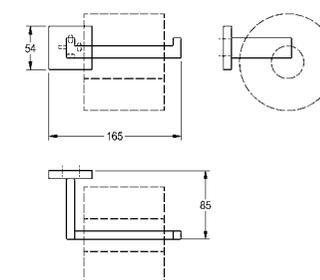

Toilet Brush Holder



Medius

- Toilet Brush for wall mounting
- 304 Stainless steel handle with nylon brush
- Glass Cup
- Round covers to conceal the fixing of screws
- Including SS screws and dowels
- 115x140x340 mm

MEDX005 2000106248
Satin Finished

MEDX005HP 2000106249
High Polished

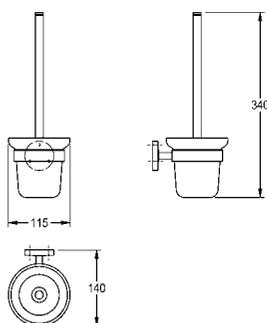

Firmus and Icarus

- Toilet Brush for wall mounting
- 304 Stainless steel handle with nylon brush
- Glass Cup
- Round covers with drilled hole on bottom for fixation
- Including SS screws and dowels
- 115x140x340 mm

FIRX005 2000106272
Satin Finished

FIRX005HP 2000106273
High Polished

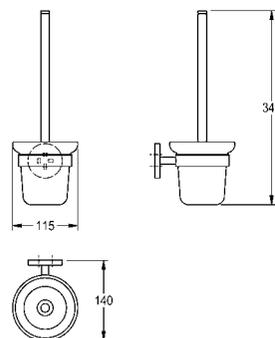

Venus

- Toilet Brush for wall mounting
- 304 Stainless steel handle with nylon brush
- Square Glass Cup
- Drilled hole on bottom for fixation
- Including SS screws and dowels
- 92x118x340 mm

VENX005 2000106330
Satin Finished

VENX005HP 2000106331
High Polished

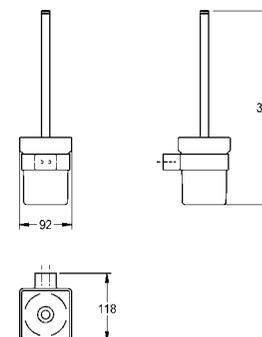

Cubus

- Toilet Brush for wall mounting
- 304 Stainless steel handle with nylon brush
- Square Glass Cup
- Square covers with drilled hole on bottom for fixation
- Including SS screws and dowels
- 147x135x340 mm

CUBX005 2000106352
Satin Finished

CUBX005HP 2000106353
High Polished

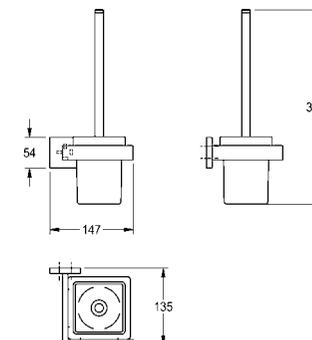



Bath Grab Bar 14 Inch

- Grab Bar for wall mounting
- 304 Stainless steel - 25mm pipe diameter
- Easy grip surface
- Round covers to conceal the fixing of screws
- Including SS screws and dowels
- 411x77x55 mm

Bath Grab Bar 18 Inch

- Grab Bar for wall mounting
- 304 Stainless steel - 25mm pipe diameter
- Easy grip surface
- Round covers to conceal the fixing of screws
- Including SS screws and dowels
- 512x77x55 mm

Angle Grab Bar

- 135° Angle Grab Bar for wall mounting
- 304 Stainless steel - 25mm pipe diameter
- Easy grip surface
- Round covers to conceal the fixing of screws
- Including SS screws and dowels
- 500x77x240 mm

Angle Grab Bar with Soap Basket

- 135° Angle Grab Bar with wire formed soap dish for wall mounting
- 304 Stainless steel - 25mm pipe diameter
- Easy grip surface
- Round covers to conceal the fixing of screws
- Including SS screws and dowels
- 500x120x240 mm

MISX30014 2000106190
Satin Finished

MISX30118 2000106191
Satin Finished

MISX30218 2000106192
Satin Finished

MISX30018 2000106382
Satin Finished

MISX30014HP 2000106377
High Polished

MISX30118HP 2000106378
High Polished

MISX30218HP 2000106379
High Polished

MISX30018HP 2000106383
High Polished

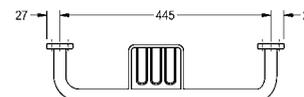
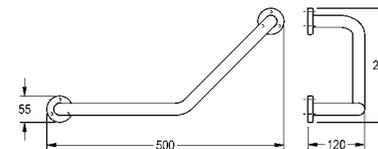
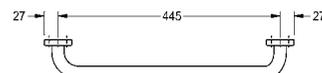
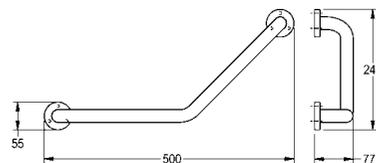
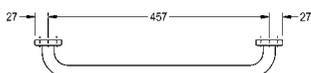
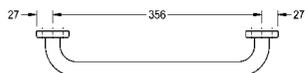
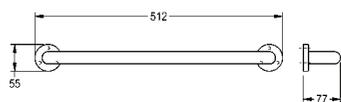
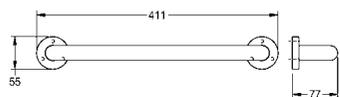

ACCREDITATIONS



Recertified in 2012, having held the prestigious accreditation since 2008, ISO9001 is a rigorous set of standards recognised globally. It provides our customers with the peace of mind that Franke has demonstrated the highest quality control of activities to ensure that the needs and expectations of our customers are met.



Most of our products are CE marked which demonstrates that they are suitable to be sold in the European union as they conform with the essential requirements of the applicable EC directives.



Franke manufacture, distribute, commission and service a comprehensive range of water efficient washroom products including low flush, ultra low flush and waterless WCs and urinals. These help to significantly reduce the amount of water used in washrooms and can assist specifiers in achieving BREEAM points for specific projects.



The Enhanced Capital Allowance (ECA) scheme enables businesses to claim up to 100% first year capital allowances on investments in technologies and products that encourage sustainable water use. The Water Technology List (WTL) provides details of products that qualify for this. Look for the logo on applicable products.

BS EN 997 - This British standard outlines the requirements for WCs from the perspective of construction and performance, emphasising functional criteria. All the WC's are manufactured at our subsidiary Franke Sissons in United Kingdom and have met the performance criteria for 4, 5 and 6 litre flushing.



Franke Washroom Systems AG
Franke Street 9, CH-4663 Aarburg,
Switzerland
Tel: +41 (0)62 7873131
Fax: +41 (0)62 7873030
www.franke.com



FRANKE

الوكيل الوحيد بالمملكة العربية السعودية
مؤسسة سدر المعادن - جدة
معرض سدر استينلس إستيل
مدينة البناء - D-49
هاتف: 02 - 6052992 جوال: 0535455588
www.sdr-metal.com.sa
E-mail: info@sdr-metal.com.sa